

ANTGALIAI IR JUNGTYŠ ŽARNOMS





Antgaliai kurui, S tipo

Medžiaga: Žalvaris (prieinamas nerūdijantis plienas)
Sandarinimas: PU (poliuretanas) - S1 tipo
Darbin. slėgis: Iki 16 barų
Vakuumin. slėgis: Iki -0,8 bar
Darbinė temp.: Nuo -20°C iki +65°C

Charakteristika: Susukami antgaliai kurui, pagaminti pagal EN 14424 normą, suprojektuoti guminiems ir termoplastiniems žarnoms degiems bei nedegiems skysčiams ir dujoms transportuoti. Plačiai naudojami kuro pramonėje žarnose, skirtose kurui, dujoms (pvz., LPG), chemikalams, kitiems skysčiams transportuoti ir platinti.

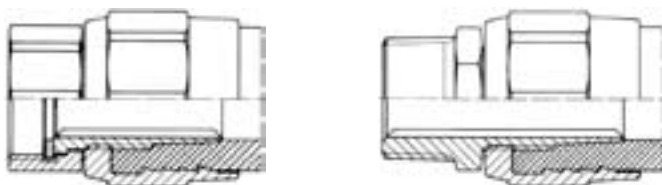
Įrengimas: Žarną įdėti į presavimo gilžę. Teisingą žarnos padėtį patikrinti per kontrolinę angą gilžėje. Įsukti antgalį į žarną ir tuo pačiu į presuojamą gilžę, užsukdami abidvi jungties dalis. Užsukus, žarna yra įspausta į gilžės sienelę.

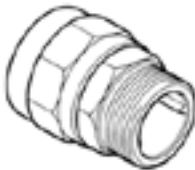

aprašymas	indeksas	žarnos dydis [mm]	sriegio dydis [coliais]	masė [kg]	
	ZP-S1-050-1305-B	13x5	1/2	0,13	
	ZP-S1-075-1505-B	15x5	3/4	0,14	
	ZP-S1-075-1904-B	19x4	3/4	0,15	
	ZP-S1-075-1905-B	19x5	3/4	0,16	
	ZP-S1-075-1906-B	19x6	3/4	0,17	
	ZP-S1-100-1505-B	15x5	1	0,15	
	ZP-S1-100-1904-B	19x4	1	0,17	
	ZP-S1-100-1905-B	19x5	1	0,18	
	ZP-S1-100-1906-B	19x6	1	0,19	
	ZP-S1-100-2505-B	25x5	1	0,21	
	ZP-S1-100-2506-B	25x6	1	0,24	
	ZP-S1-125-3206-B	32x6	1.1/4	0,38	
	ZP-S1-150-3806-B	38x6,5	1.1/2	0,60	
	S2 - išorinis BSPT sriegis	ZP-S2-050-1305-B	13x5	1/2	0,12
	S3 - išorinis NPT sriegis	ZP-S2-075-1505-B	15x5	3/4	0,17
	S4 - išorinis BSP sriegis	ZP-S2-075-1904-B	19x4	3/4	0,17
		ZP-S2-075-1905-B	19x5	3/4	0,18
		ZP-S2-075-1906-B	19x6	3/4	0,19
		ZP-S3-075-1505-B	15x5	3/4	0,17
		ZP-S3-075-1904-B	19x4	3/4	0,17
		ZP-S3-075-1905-B	19x5	3/4	0,18
		ZP-S3-075-1906-B	19x6	3/4	0,19
		ZP-S3-100-2505-B	25x5	1	0,19
		ZP-S3-100-2506-B	25x6	1	0,20
		ZP-S4-100-1904-B	19x4	1	0,19
		ZP-S4-100-1905-B	19x5	1	0,20
		ZP-S4-100-1906-B	19x6	1	0,21
		ZP-S4-100-2505-B	25x5	1	0,25
		ZP-S4-100-2506-B	25x6	1	0,28
		ZP-S4-125-3206-B	32x6	1.1/4	0,44
	ZP-S4-150-3806-B	38x6,5	1.1/2	0,56	

ANTGALIAI IR JUNGTYŠ ŽARNOMS



CNP

Medžiaga: Cinkuotas plienas, AISI 304 plienas, žalvaris

Darbinis slėgis: 10 barų

Charakteristika: Antgalis pramoninėms žarnoms, užbaigtas išoriniu BSPT sriegiu. Gaminamas ir su NPT sriegiu.

indeksas (cinkuotas plienas)	indeksas (plienas AISI 304)	indeksas (žalvaris)	sriegio dydis [coliais]	žarnos skersmuo [mm]
AC-CNP-050	AC-CNP-050-SS	AC-CNP-050-MS	1/2	13
AC-CNP-075	AC-CNP-075-SS	AC-CNP-075-MS	3/4	19
AC-CNP-100	AC-CNP-100-SS	AC-CNP-100-MS	1	25
AC-CNP-125	AC-CNP-125-SS	AC-CNP-125-MS	1.1/4	32
AC-CNP-150	AC-CNP-150-SS	AC-CNP-150-MS	1.1/2	40
AC-CNP-200	AC-CNP-200-SS	AC-CNP-200-MS	2	50
AC-CNP-250	AC-CNP-250-SS	AC-CNP-250-MS	2.1/2	65
AC-CNP-300	AC-CNP-300-SS	AC-CNP-300-MS	3	75
AC-CNP-400	AC-CNP-400-SS	AC-CNP-400-MS	4	100
AC-CNP-500	AC-CNP-500-SS	AC-CNP-500-MS	5	125
AC-CNP-600	AC-CNP-600-SS	AC-CNP-600-MS	6	150
AC-CNP-800	AC-CNP-800-SS	AC-CNP-800-MS	8	200



CNW

Medžiaga: Anglinis plienas, AISI 304 plienas

Darbinis slėgis: 10 barų

Charakteristika: Antgalis pramoninėms žarnoms, su suvirinamu atvamzdžiu.

indeksas (anglinis plienas)	indeksas (plienas AISI 304)	atvamzdžio dydis [coliais]	žarnos skersmuo [mm]
AC-CNW-050	AC-CNW-050-SS	1/2	13
AC-CNW-075	AC-CNW-075-SS	3/4	19
AC-CNW-100	AC-CNW-100-SS	1	25
AC-CNW-125	AC-CNW-125-SS	1.1/4	32
AC-CNW-150	AC-CNW-150-SS	1.1/2	40
AC-CNW-200	AC-CNW-200-SS	2	50
AC-CNW-250	AC-CNW-250-SS	2.1/2	65
AC-CNW-300	AC-CNW-300-SS	3	75
AC-CNW-400	AC-CNW-400-SS	4	100
AC-CNW-500	AC-CNW-500-SS	5	125
AC-CNW-600	AC-CNW-600-SS	6	150
AC-CNW-800	AC-CNW-800-SS	8	200

ANTGALIAI IR JUNGTYŠ ŽARNOMS



CW

Medžiaga: Plienas AISI 304
Darbinis slėgis: 10 barų

Charakteristika: Suvirinamas antgalis, užbaigtas išoriniu BSPT sriegiu. Gaminamas ir su NPT sriegiu.

indeksas (plienas AISI 304)	žarnos skersmuo [coliais]	ilgis [mm]
AC-CW-006-SS	1/4	51
AC-CW-009-SS	3/8	51
AC-CW-013-SS	1/2	51
AC-CW-019-SS	3/4	76
AC-CW-025-SS	1	76
AC-CW-038-SS	1.1/2	76
AC-CW-051-SS	2	102
AC-CW-076-SS	3	102
AC-CW-102-SS	4	102

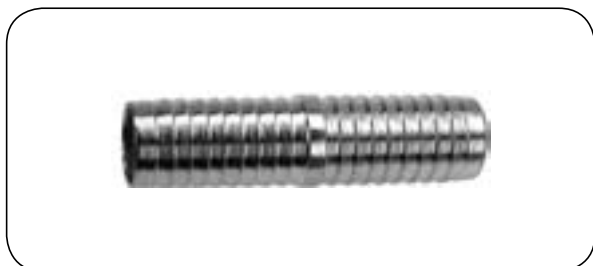

DMP

Medžiaga: Anglinis plienas, plienas AISI 304
Darbinis slėgis: 10 barų

Charakteristika: Jungtys pramoninėms žarnoms.

indeksas (anglinis plienas)	indeksas (plienas AISI 304)	žarnos skersmuo [coliais]	žarnos skersmuo [mm]
DX-DMPA	DX-DMPA-SS	1/4	6
DX-DMPB	DX-DMPB-SS	3/8	10
DX-DMP1	DX-DMP1-SS	1/2	13
DX-DMP5	DX-DMP5-SS	5/8	16
DX-DMP6	DX-DMP6-SS	3/4	19
DX-DMP11	DX-DMP11-SS	1	25
DX-DMP16	DX-DMP16-SS	1.1/4	32
DX-DMP18	DX-DMP18-SS	1.3/8	35
DX-DMP21	DX-DMP21-SS	1.1/2	40
DX-DMP26	DX-DMP26-SS	2	50
DX-DMP31	DX-DMP31-SS	2.1/2	65
DX-DMP36	DX-DMP36-SS	3	75
DX-DMP46	DX-DMP46-SS	4	100
DX-DMP51	DX-DMP51-SS	5	125
DX-DMP66	DX-DMP66-SS	6	150
DX-DMP86	DX-DMP86-SS	8	200
DX-DMP100	DX-DMP100-SS	10	250
DX-DMP120	DX-DMP120-SS	12	300

ANTGALIAI IR JUNGTYŠ ŽARNOMS

Žalvarinės jungtys MU

Skirtos pneumatinėms, vandens ir pan. sistemoms.



indeksas	sriegio dydis [coliais]	sriegio dydis [coliais]	rakto dydis [mm]	aprašymas
MU-4201	1/8	1/8	14	Jungtis - 2 x išorinis BSP sriegis su vidiniu kūgiu. Medžiaga: žalvaris.
MU-4202	1/8	1/4	17	
MU-4203	1/4	1/4	17	
MU-4204	1/4	3/8	19	
MU-4208	1/4	1/2	24	
MU-4205	3/8	3/8	19	
MU-4206	3/8	1/2	24	
MU-4213	3/8	3/4	32	
MU-4207	1/2	1/2	24	
MU-4209	1/2	3/4	32	
MU-4215	1/2	1	36	
MU-4211	3/4	3/4	32	
MU-4210	3/4	1	36	
MU-4216	1	1	36	



indeksas	išor. sriegio dydis [coliais]	vid. sriegio dydis [coliais]	rakto dydis [mm]	aprašymas
MU-4251	1/4	1/8	17	Redukcinė jungtis - išorinis x vidinis BSP sriegis. Medžiaga: žalvaris.
MU-4256	3/8	1/8	19	
MU-4252	3/8	1/4	19	
MU-4257	1/2	1/8	24	
MU-4254	1/2	1/4	24	
MU-4253	1/2	3/8	21	
MU-4258	3/4	3/8	32	
MU-4255	3/4	1/2	32	
MU-4259	1	1/2	36	
MU-4260	1	3/4	36	



indeksas	sriegio dydis [coliais]	aprašymas
MU-1142	1/8	Alkūnė 90°, 2 x vidinis BSP sriegis. Medžiaga: žalvaris.
MU-1143	1/4	
MU-1144	3/8	
MU-1145	1/2	
MU-1146	3/4	
MU-1147	1	



indeksas	sriegio dydis [coliais]	aprašymas
MU-1172	1/8	Trišakis, 3 x vidinis BSP sriegis. Medžiaga: žalvaris
MU-1173	1/4	
MU-1174	3/8	
MU-1175	1/2	
MU-1176	3/4	
MU-1177	1	

ANTGALIAI IR JUNGTYJS ŽARNOMS

Armatūra iš rūgščiai atsparaus plieno

Medžiaga: Plienas AISI 316

Darbinis slėgis: 10 barų



90° alkūnė su vidiniu BSP sriegiu

VT 101

indeksas	dydis	sriegio dydis [coliais]
NM-VT101-04	8	1/4
NM-VT101-06	10	3/8
NM-VT101-08	15	1/2
NM-VT101-12	20	3/4
NM-VT101-16	25	1
NM-VT101-20	32	1.1/4
NM-VT101-24	40	1.1/2
NM-VT101-32	50	2
NM-VT101-40	65	2.1/2
NM-VT101-48	80	3
NM-VT101-64	100	4



45° alkūnė su vidiniu BSP sriegiu

VT 107

indeksas	dydis	sriegio dydis [coliais]
NM-VT107-04	8	1/4
NM-VT107-06	10	3/8
NM-VT107-08	15	1/2
NM-VT107-12	20	3/4
NM-VT107-16	25	1
NM-VT107-20	32	1.1/4
NM-VT107-24	40	1.1/2
NM-VT107-32	50	2



90° alkūnė-įmova su vidiniu BSP / išoriniu BSPT sriegiu

VT 153

indeksas	dydis	sriegio dydis [coliais]
NM-VT153-04	8	1/4
NM-VT153-06	10	3/8
NM-VT153-08	15	1/2
NM-VT153-12	20	3/4
NM-VT153-16	25	1
NM-VT153-20	32	1.1/4
NM-VT153-24	40	1.1/2
NM-VT153-32	50	2
NM-VT153-40	65	2.1/2
NM-VT153-48	80	3



Trišakis su vidiniu BSP sriegiu

VT 103

indeksas	dydis	sriegio dydis [coliais]
NM-VT103-04	8	1/4
NM-VT103-06	10	3/8
NM-VT103-08	15	1/2
NM-VT103-12	20	3/4
NM-VT103-16	25	1
NM-VT103-20	32	1.1/4
NM-VT103-24	40	1.1/2
NM-VT103-32	50	2
NM-VT103-40	65	2.1/2
NM-VT103-48	80	3

ANTGALIAI IR JUNGTYŠ ŽARNOMS

Armatūra iš rūgščiai atsparaus plieno

Medžiaga: Plienas AISI 316

Darbinis slėgis: 10 barų



indeksas	dydis	1, 2 sriegio dydis [coliais]	3 sriegio dydis [coliais]
NM-VT104-06-04	10	3/8	1/4
NM-VT104-08-04	15	1/2	1/4
NM-VT104-08-06	15	1/2	3/8
NM-VT104-12-06	20	3/4	3/8
NM-VT104-12-08	20	3/4	1/2
NM-VT104-16-08	25	1	1/2
NM-VT104-16-12	25	1	3/4
NM-VT104-24-12	40	1.1/2	3/4
NM-VT104-32-12	50	2	3/4
NM-VT104-32-16	50	2	1
NM-VT104-32-24	50	2	1.1/2



indeksas	dydis	sriegio dydis [coliais]
NM-VT105-04	8	1/4
NM-VT105-06	10	3/8
NM-VT105-08	15	1/2
NM-VT105-12	20	3/4
NM-VT105-16	25	1
NM-VT105-20	32	1.1/4
NM-VT105-24	40	1.1/2
NM-VT105-32	50	2
NM-VT105-40	65	2.1/2
NM-VT105-48	80	3
NM-VT105-64	100	4



indeksas	dydis	sriegio dydis [coliais]	rakto dydis [mm]
NM-VT116-04	8	1/4	14
NM-VT116-06	10	3/8	19
NM-VT116-08	15	1/2	22
NM-VT116-12	20	3/4	30
NM-VT116-16	25	1	36
NM-VT116-20	32	1.1/4	46
NM-VT116-24	40	1.1/2	50
NM-VT116-32	50	2	65
NM-VT116-40	65	2.1/2	81
NM-VT116-48	80	3	92
NM-VT116-64	100	4	120



indeksas	dydis	1 sriegio dydis [coliais]	2 sriegio dydis [coliais]	rakto dydis [mm]
NM-VT117-04-02	8	1/4	1/8	14
NM-VT117-06-04	10	3/8	1/4	19
NM-VT117-08-06	15	1/2	3/8	22
NM-VT117-12-08	20	3/4	1/2	30
NM-VT117-16-12	25	1	3/4	36
NM-VT117-20-16	32	1.1/4	1	46
NM-VT117-24-20	40	1.1/2	1.1/4	50
NM-VT117-32-24	50	2	1.1/2	65

ANTGALIAI IR JUNGTYŠ ŽARNOMS

Armatūra iš rūgščiai atsparaus plieno

Medžiaga: Plienas AISI 316

Darbinis slėgis: 10 barų



Suvirinama įmova su išor. BSPT sriegiu

VT 126

indeksas	dydis	sriegio dydis [coliais]	skersmuo [mm]	sienelės storis [mm]
NM-VT126-04	8	1/4	13,5	2,3
NM-VT126-06	10	3/8	17,2	2,3
NM-VT126-08	15	1/2	21,3	2,6
NM-VT126-12	20	3/4	26,9	2,6
NM-VT126-16	25	1	33,7	3,2
NM-VT126-20	32	1.1/4	42,4	3,2
NM-VT126-24	40	1.1/2	48,3	3,2
NM-VT126-32	50	2	60,3	3,6
NM-VT126-40	65	2.1/2	76,1	3,6
NM-VT126-48	80	3	88,9	4
NM-VT126-64	100	4	114,3	4,5



Dviguba įmova su išor. BSPT sriegiu

VT 127

indeksas	dydis	sriegio dydis [coliais]	skersmuo [mm]	sienelės storis [mm]
NM-VT127-04	8	1/4	13,5	2,3
NM-VT127-06	10	3/8	17,2	2,3
NM-VT127-08	15	1/2	21,3	2,6
NM-VT127-12	20	3/4	26,9	2,6
NM-VT127-16	25	1	33,7	3,2
NM-VT127-20	32	1.1/4	42,4	3,2
NM-VT127-24	40	1.1/2	48,3	3,2
NM-VT127-32	50	2	60,3	3,6
NM-VT127-40	65	2.1/2	76,1	3,6
NM-VT127-48	80	3	88,9	4
NM-VT127-64	100	4	114,3	4,5



Įmova su antgalium žarnai su išor. BSPT sriegiu

VT 123

indeksas	dydis	sriegio dydis [coliais]	šrednica koñcòwki [mm]	su žarnai [coliais]
NM-VT123-02	6	1/8	6,7	1/4
NM-VT123-04	8	1/4	9	5/16
NM-VT123-06	10	3/8	10,5	3/8
NM-VT123-08	15	1/2	14	1/2
NM-VT123-12	20	3/4	20,5	3/4
NM-VT123-16	25	1	27,5	1
NM-VT123-20	32	1.1/4	34	1.1/4
NM-VT123-24	40	1.1/2	40,3	1.1/2
NM-VT123-32	50	2	52	2
NM-VT123-40	65	2.1/2	65	2.1/2
NM-VT123-48	80	3	77	3



Mova su išor. BSP sriegiu

VT 1221

indeksas	dydis	sriegio dydis [coliais]	dydis [mm]	ilgis [mm]
NM-VT1221-04	8	1/4	18	26,5
NM-VT1221-06	10	3/8	21	29
NM-VT1221-08	15	1/2	25	33
NM-VT1221-12	20	3/4	31	34,5
NM-VT1221-16	25	1	38	41,5
NM-VT1221-20	32	1.1/4	47	47,5
NM-VT1221-24	40	1.1/2	52	47,5
NM-VT1221-32	50	2	68	62
NM-VT1221-40	65	2.1/2	84,5	70
NM-VT1221-48	80	3	97	76
NM-VT1221-64	100	4	125	86

ANTGALIAI IR JUNGTYŠ ŽARNOMS

Armatūra iš rūgščiai atsparaus plieno

Medžiaga: Plienas AISI 316

Darbinis slėgis: 10 barų



indeksas	dydis	sriegio dydis [coliais]	skersmuo [mm]	ilgis [mm]
NM-VT102-04	8	1/4	18,5	11
NM-VT102-06	10	3/8	21,3	12
NM-VT102-08	15	1/2	26,4	15
NM-VT102-12	20	3/4	31,8	15
NM-VT102-16	25	1	39,5	19
NM-VT102-20	32	1.1/4	48,3	22
NM-VT102-24	40	1.1/2	54,5	22
NM-VT102-32	50	2	66,3	26

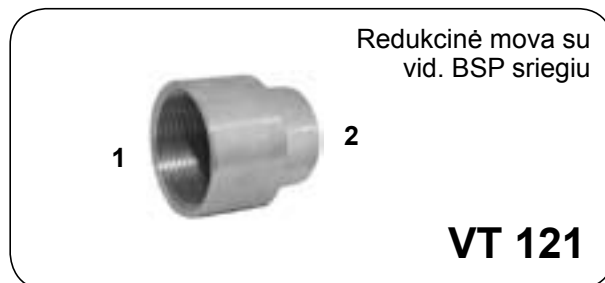

indeksas	dydis	1 sriegio dydis [coliais]	2 sriegio dydis [coliais]	ilgis [mm]
NM-VT121-06-04	10	3/8	1/4	30
NM-VT121-08-04	15	1/2	1/4	34
NM-VT121-08-06	15	1/2	3/8	34
NM-VT121-12-06	20	3/4	3/8	38
NM-VT121-12-08	20	3/4	1/2	38
NM-VT121-16-08	25	1	1/2	42
NM-VT121-16-12	25	1	3/4	42
NM-VT121-20-12	32	1.1/4	3/4	48
NM-VT121-20-16	32	1.1/4	1	48
NM-VT121-24-16	40	1.1/2	1	52
NM-VT121-24-20	40	1.1/2	1.1/4	52
NM-VT121-32-24	50	2	1.1/2	58

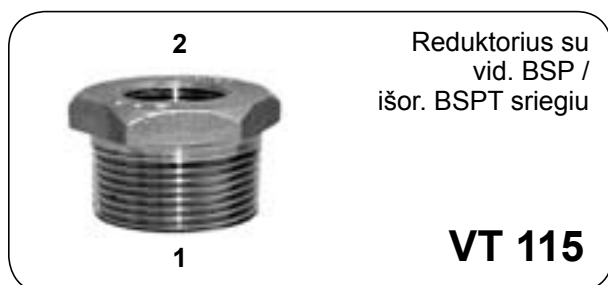

indeksas	dydis	1 sriegio dydis [coliais]	2 sriegio dydis [coliais]	rakto dydis [mm]
NM-VT115-04-02	8	1/4	1/8	14
NM-VT115-06-02	10	3/8	1/8	19
NM-VT115-06-04	10	3/8	1/4	19
NM-VT115-08-04	15	1/2	1/4	22
NM-VT115-08-06	15	1/2	3/8	22
NM-VT115-12-04	20	3/4	1/4	30
NM-VT115-12-06	20	3/4	3/8	30
NM-VT115-12-08	20	3/4	1/2	30
NM-VT115-16-04	25	1	1/4	36
NM-VT115-16-06	25	1	3/8	36
NM-VT115-16-08	25	1	1/2	36
NM-VT115-16-12	25	1	3/4	36
NM-VT115-20-08	32	1.1/4	1/2	46
NM-VT115-20-12	32	1.1/4	3/4	46
NM-VT115-20-16	32	1.1/4	1	46
NM-VT115-24-12	40	1.1/2	3/4	50
NM-VT115-24-16	40	1.1/2	1	50
NM-VT115-24-20	40	1.1/2	1.1/4	50
NM-VT115-32-16	50	2	1	65
NM-VT115-32-20	50	2	1.1/4	65
NM-VT115-32-24	50	2	1.1/2	65



indeksas	sriegio dydis [coliais]	rakto dydis [mm]
NM-VT118-04	1/4	19
NM-VT118-06	3/8	23
NM-VT118-08	1/2	27
NM-VT118-12	3/4	35
NM-VT118-16	1	41
NM-VT118-20	1.1/4	50
NM-VT118-24	1.1/2	56
NM-VT118-32	2	70
NM-VT118-40	2.1/2	84
NM-VT118-48	3	99

ANTGALIAI IR JUNGTYŠ ŽARNOMS

Armatūra iš rūgščiai atsparaus plieno

Medžiaga: Plienas AISI 316

Darbinis slėgis: 10 barų

Veržlė su
vid. BSP sriegiu



VT 124

indeksas	sriegio dydis [coliais]	rakto dydis [mm]
NM-VT124-04	1/4	22
NM-VT124-06	3/8	27
NM-VT124-08	1/2	32
NM-VT124-12	3/4	36
NM-VT124-16	1	46
NM-VT124-20	1.1/4	55
NM-VT124-24	1.1/2	60
NM-VT124-32	2	75
NM-VT124-40	2.1/2	95
NM-VT124-48	3	105
NM-VT124-64	4	135

Kamštis su
keturkampe galvute
su išor. BSPT sriegiu



VT 113

indeksas	sriegio dydis [coliais]	rakto dydis [mm]
NM-VT113-04	1/4	9
NM-VT113-06	3/8	12
NM-VT113-08	1/2	14
NM-VT113-12	3/4	17
NM-VT113-16	1	19
NM-VT113-20	1.1/4	23
NM-VT113-24	1.1/2	32
NM-VT113-32	2	32

Kamštis su
šešiakampe galvute,
su išor. BSPT sriegiu



VT 114

indeksas	sriegio dydis [coliais]	rakto dydis [mm]
NM-VT114-04	1/4	17
NM-VT114-06	3/8	21
NM-VT114-08	1/2	23
NM-VT114-12	3/4	29
NM-VT114-16	1	36
NM-VT114-20	1.1/4	46
NM-VT114-24	1.1/2	50
NM-VT114-32	2	60
NM-VT114-40	2.1/2	80
NM-VT114-48	3	92

Srieginė jungtis
su vid. BSP sriegiu
sandar. kūgias



VT 108

indeksas	sriegio dydis [coliais]	jungties ilgis [mm]	rakto dydis [mm]
NM-VT108-04	1/4	32	28
NM-VT108-06	3/8	39	32
NM-VT108-08	1/2	41	41
NM-VT108-12	3/4	47	46
NM-VT108-16	1	52	60
NM-VT108-20	1.1/4	55	68
NM-VT108-24	1.1/2	60	78
NM-VT108-32	2	70	85
NM-VT108-40	2.1/2	90	110
NM-VT108-48	3	105	128

ANTGALIAI IR JUNGTYŠ ŽARNOMS

Armatūra iš rūgščiai atsparaus plieno

Medžiaga: Plienas AISI 316

Darbinis slėgis: 10 barų



Srieginė jungtis su
vid. BSP /
išor. BSPT sriegiu
sandar. kūgis

VT 109



Srieginė suvirinama
jungtis su
vid. BSP sriegiu
sandar. kūgis

VT 110

indeksas	sriegio dydis [coliais]	jungties ilgis [mm]	rakto dydis [mm]
NM-VT109-04	1/4	43	30
NM-VT109-06	3/8	50	32
NM-VT109-08	1/2	57	41
NM-VT109-12	3/4	63	46
NM-VT109-16	1	74	55
NM-VT109-20	1.1/4	80	61
NM-VT109-24	1.1/2	84	75
NM-VT109-32	2	95	85
NM-VT109-40	2.1/2	110	109
NM-VT109-48	3	125	125

indeksas	vid. vamz. skersmuo [mm]	išor. vamz. skersmuo [mm]	srieg. jung. ilgis [mm]	rakto dydis [mm]
NM-VT110-13,8	9	13,8	34	27
NM-VT110-17,0	12	17	40	28
NM-VT110-21,3	15	21,3	44	32
NM-VT110-26,9	20	26,9	55	41
NM-VT110-33,3	26	33,3	65	50
NM-VT110-42,4	35	42,4	67	60
NM-VT110-48,3	38	48,3	71	70
NM-VT110-60,3	50	60,3	75	85
NM-VT110-76,1	65	76,1	85	109
NM-VT110-88,9	80	88,9	96	125
NM-VT110-114,3	100	114,3	100	156

ANTGALIAI IR JUNGTYŠ ŽARNOMS

EC tipo antgaliai

EC antgaliai yra skirti žemo slėgio žarnų (maksimalus darbinis slėgis, priklausomai nuo skersmens, iki apie 30 barų) apkaustymui, ypač guminių ir plastmasinių nesutvirtintų bei su tekstiliniu sutvirtinimu, su išoriniu plieninių apipynimu ir pan. Užpresuojami skardinėmis gilzėmis presavimo įrenginio, skirto žemo slėgio žarnoms, pagalba (žiūrėti skyrių ĮRENGINIAI IR PRIEDAI).

Skirtingai nei hidrauliniai antgaliai, EC antgaliai neturi užrakto, jungiančio gilze su antgaliu. Plačiai naudojamos lankščiose žarnose, skirtose sanitarinei armatūrai, kuro, oro sistemoms ir pan. EC gilzės taip pat gali būti naudojamos ir NiTO antgaliams bei greito sujungimo antgaliams užpresuoti.

aprašymas	indeksas (cinkuotas plienas)	indeksas (plienas 304)	vidinis skersmuo [mm]	angos skersmuo [mm]	ilgis [mm]
 Skardinė įvorė H tipo	EC-104040	-	9	5,5	17
	EC-104050	-	10	6,5	17
	EC-104051	-	11	6,5	17
	EC-104060	EC-104260	11	7,5	17
	EC-104061	-	12	12	19
	EC-104062	EC-104262	12	7,5	20
	EC-104063	-	13,5	7,5	20
	EC-104064	-	12	7,5	10
	EC-104065	-	15	7,5	20
	-	EC-104263	12	9	15
	EC-104080	EC-104280	13,5	10	20
	EC-104082	-	12,5	10	15
	EC-104084	EC-104284	14	10	20
	EC-104085	-	15	10	20
	EC-104089	-	14	10	22
	EC-104099	-	14,5	11,7	16
	EC-104105	EC-104305	15	11,7	20
	EC-104100	EC-104300	16	11,7	20
	EC-104106	-	15	11,7	16
	EC-104107	EC-104307	17	11,7	21
	EC-104118	EC-104318	18	13,8	21
	EC-104112	EC-104312	19	13,8	26
	EC-104120	-	20	13,8	26
	EC-104121	-	22	13,8	22
	-	EC-104319	22	13,8	26
	EC-104122	-	22	15,6	32
	EC-104123	-	23	17	32
	-	EC-104323	23	18,4	28
	-	EC-104324	24,5	17	31
	EC-104124	-	24,5	17	33
	EC-104126	-	26,5	19,5	33
	EC-104128	-	28	20,5	34
	-	EC-104327	29	20,7	30
	EC-104130	-	30	24	32
	-	EC-104331	31	24	34
	EC-104132	-	32	24	34
EC-104133	-	33	24	34	
EC-104136	-	34	24	34	
EC-104138	-	36	25	35	
EC-104140	-	38	27	35	
EC-104142	-	40	28	40	
-	EC-104340	40	30	35	
EC-104145	-	45	35	36	



ANTGALIAI IR JUNGTYŠ ŽARNOMS

EC tipo antgaliai

aprašymas	indeksas (cinkuotas plienas)	sutartinis nominalus skersmuo DN	apytikslis vid. žarnos skersmuo [mm]	naudoti UM tipo veržlę
<p>Atvamzdis S tipo (rutulinis antgalis, sandarinimas 60° kūgis, panašus į DIN 7608)</p> 	EC-105050	3	4,5	M10x1 arba 1/8"
	EC-105060	4	5,5	M12x1,5 arba 1/4"
	EC-105068	4/6	5,5	M14x1,5
	EC-105069	4/8	5,5	M16x1,5
	EC-105080	6	7,5	M14x1,5 arba 1/4"
	EC-105081	6/8	7,5	M16x1,5
	EC-105100	8	9,5	M16x1,5 arba 3/8"
	EC-105102	8/10	9,5	M18x1,5
	EC-105112	10	11,5	M18x1,5
	EC-105114	10/12	11,5	M22x1,5
	EC-105150	12	14,5	M22x1,5
	EC-105156	12/16	14,5	M26x1,5
	EC-105186	16	17	M26x1,5
	EC-105113	10	11,5	1/2"
	EC-105151	12	14,5	1/2"
	EC-105231	20	19,5	3/4"
EC-105233	20	19,5	1"	

aprašymas	indeksas (cinkuotas plienas)	sutartinis nominalus skersmuo DN	apytikslis vid. žarnos skersmuo [mm]	naudoti UM tipo veržlę
<p>Atvamzdis SF tipo (sandarinimas plokščias)</p> 	EC-105205	3	4,5	M10x1 arba 1/8"
	EC-105206	4	5,5	M12x1,5 arba 1/4"
	EC-105208	6	7,5	M14x1,5 arba 1/4"
	EC-105210	8	9,5	M16x1,5 arba 3/8"
	EC-105212	10	11,5	M18x1,5
	EC-105215	12	14,5	
	EC-105226	12/16	14,5	M26x1,5
	EC-105228	16	17	M26x1,5
	EC-105213	10	11,5	1/2"
	EC-105216	12	14,5	1/2"
	EC-105230	20	19,5	3/4"
	EC-105232	20	19,5	1"

aprašymas	indeksas (cinkuotas plienas)	sutartinis nominalus skersmuo DN	sriegio dydis	rakto dydis [mm]
<p>Veržlė UM tipo (panaši į DIN 3870)</p> 	EC-105510	3	M10x1	12
	EC-105512	4	M12x1,5	14
	EC-105514	6	M14x1,5	17
	EC-105516	8	M16x1,5	19
	EC-105518	10	M18x1,5	22
	EC-105522	12	M22x1,5	27
	EC-105526	16	M26x1,5	32
	EC-105605	3	1/8" BSP	14
	EC-105606	4	1/4" BSP	17
	EC-105608	6	1/4" BSP	17
	EC-105610	8	3/8" BSP	19
	EC-105612	10	1/2" BSP	24
	EC-105609	6	1/4" BSP LH (kairys)	17
	EC-105611	8	3/8" BSP LH (kairys)	19

ANTGALIAI IR JUNGTYŠ ŽARNOMS

EC tipo antgaliai

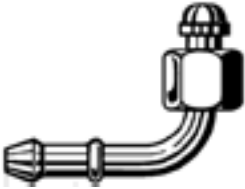
aprašymas	indeksas (cinkuotas plienas)	sutartinis nominalus skersmuo DN	apytikslis vid. žarnos skersmuo [mm]	sriegio dydis
<p>Kampinis 90° antgalis RBU tipo (rutulinis, sandarinimas 60° kūgis)</p> 	EC-108210	3	4,5	M10x1,0
	EC-108212	4	5,5	M12x1,5
	EC-108214	6	7,5	M14x1,5
	EC-108216	8	9,5	M16x1,5
	EC-108218	10	11,5	M18x1,5
	EC-108222	12	14,5	M22x1,5

aprašymas	indeksas (cinkuotas plienas)	išor. vamzdelio skersmuo [mm]	naudoti UM tipo veržlę
<p>Įmova LN tipo, skirta litavimui (rutulinė, sandarinimas 60° kūgis, panašus į DIN 7608)</p> 	EC-109705	5	M10x1
	EC-109706	6	M12x1,5
	EC-109708	8	M14x1,5
	EC-109710	10	M16x1,5
	EC-109712	12	M18x1,5
	EC-109715	15	M22x1,5
	EC-109718	18	M26x1,5

aprašymas	indeksas (cinkuotas plienas)	sutartinis nominalus skersmuo DN	apytikslis vid. žarnos skersmuo [mm]	sriegio dydis
<p>Antgalis SA tipo su išor. metriniu sriegiu (sandarinimas 60° kūgis arba plokščias)</p> 	EC-110005	3	4,5	M10x1 (kūgis 60°)
	EC-110006	4	5,5	M12x1,5 (kūgis 60°)
	EC-110008	6	7,5	M14x1,5 (kūgis 60°)
	EC-110010	8	9,5	M16x1,5 (kūgis 60°)
	EC-110012	10	11,5	M18x1,5 (kūgis 60°)
	EC-110122	12	14,5	M22x1,5 (plokščias)
	EC-110125	12/16	14,5	M26x1,5 (plokščias)
	EC-110126	16	17	M26x1,5 (plokščias)

aprašymas	indeksas (cinkuotas plienas)	sutartinis nom. skersmuo DN	apytikslis vid. žarnos skersm. [mm]	išor. vamzdelio skersmuo [mm]	sriegio dydis
<p>Antgalis SA tipo su išor. metriniu sriegiu (sandarinimas 24° kūgis)</p> 	EC-110205	3	4,5	5	M10x1
	EC-110206	4	5,5	6	M12x1,5
	EC-110208	6	7,5	8	M14x1,5
	EC-110210	8	9,5	10	M16x1,5
	EC-110212	10	11,5	12	M18x1,5
	EC-110215	12	14,5	15	M22x1,5
	EC-110216	12	14,5	16	M22x1,5
	EC-110217	12/16	14,5	18	M26x1,5
	EC-110218	16	17	18	M26x1,5

ANTGALIAI IR JUNGTYŠ ŽARNOMS

EC tipo antgaliai

aprašymas	indeksas (žalvaris)	sutartinis nominalus skersmuo DN	apytikslis vid. žarnos skersmuo [mm]	sriegio dydis [coliais]
<p>Antgalis SA tipo su išor. BSP sriegiu (sandininimas 60° kūgis)</p> 	EC-110305	3	3,5	1/8
	EC-110304	4	4,5	1/8
	EC-110306	4	5,5	1/4
	EC-110316	4	5,5	3/8
	EC-110308	6	7,5	1/4
	EC-110317	6	7,5	3/8
	EC-110310	8	9,5	3/8
	EC-110312	10	11,5	1/2
	EC-110315	12	14,5	1/2

aprašymas	indeksas (cinkuotas plienas)	išor. vamzdelio skersmuo [mm]	sriegio dydis [mm]
<p>Įmova LST tipo su išor. metriniu sriegiu, skirta litavimui (sandininimas 60° kūgis)</p> 	EC-109805	5	M10x1
	EC-109806	6	M12x1,5
	EC-109808	8	M14x1,5
	EC-109810	10	M16x1,5
	EC-109812	12	M18x1,5
	EC-109815	15	M22x1,5
	EC-109818	18	M26x1,5

aprašymas	indeksas (cinkuotas plienas)	sutartinis nominalus skersmuo DN	apytikslis vid. žarnos skersmuo [mm]	angos skersmuo
<p>Banjo antgalis RS tipo</p> 	EC-106006	2/3	3,5	6 mm
	EC-106008	3	4,5	8 mm
	EC-106010	4	5,5	10 mm = 1/8"
	EC-106012	4/6	5,5	12 mm
	EC-106014	4/8	5,5	14 mm = 1/4"
	EC-106015	4/8	5,5	13,5 mm = 1/4"
	EC-106110	6/4	7,5	10 mm
	EC-106112	6	7,5	12 mm
	EC-106114	6/8	7,5	14 mm = 1/4"
	EC-106116	6/8	7,5	16,8 mm = 3/8"
	EC-106212	8/6	9,5	12 mm
	EC-106214	8	9,5	14 mm = 1/4"
	EC-106216	8/10	9,5	16 mm
	EC-106218	8/12	9,5	18 mm
	EC-106316	10	11,5	16 mm
	EC-106318	10/12	11,5	18 mm
	EC-106418	12	14,5	18 mm
	EC-106422	12/16	14,5	22 mm
	EC-106426	12/20	14,5	26 mm
	EC-106522	16	17	22 mm
EC-106526	16/20	17	26 mm	

ANTGALIAI IR JUNGTYŠ ŽARNOMS

EC tipo antgaliai

aprašymas	indeksas (cinkuotas plienas)	sutartinis nominalus skersmuo DN	apytikslis vid. žarnos skersmuo [mm]	angos skersmuo
Dvigubas banjo antgalis DRS tipo 	EC-106808	3	4,5	8 mm
	EC-106810	4	5,5	10 mm = 1/8"
	EC-106812	6	7,5	12 mm
	EC-106814	8	9,5	14 mm = 1/4"

aprašymas	indeksas (cinkuotas plienas)	sutartinis nominalus skersmuo DN	apytikslis vid. žarnos skersmuo [mm]	angos skersmuo
Kampinis 90° banjo ant- galis RBR tipo 	EC-108008	3	4,5	8 mm
	EC-108010	4	5,5	10 mm = 1/8"
	EC-108012	6	7,5	12 mm
	EC-108014	8	9,5	14 mm = 1/4"

aprašymas	indeksas (cinkuotas plienas)	išor. vamzdelio skersmuo [mm]	angos skersmuo [mm]
Banjo angalis RL tipo, skirtas litavimui (panašus į DIN 7642) 	EC-109008	5	8
	EC-109010	6	10
	EC-109012	6	12
	EC-109014	6	14
	EC-109112	8	12
	EC-109114	8	14
	EC-109213	10	12
	EC-109214	10	14
	EC-109216	10	16
	EC-109316	12	16
	EC-109318	12	18
	EC-109418	15	18
	EC-109422	18	22
	EC-109426	18	26
	EC-109526	22	26
EC-109530	28	30	

aprašymas	indeksas (cinkuotas plienas)	išor. vamzdelio skersmuo [mm]	angos skersmuo [mm]
Dvigubas banjo antgalis DRL tipo, skirtas litavimui 	EC-109608	5	8
	EC-109610	6	10
	EC-109612	8	12
	EC-109614	10	14
	EC-109616	12	16

ANTGALIAI IR JUNGTYŠ ŽARNOMS

EC tipo antgaliai

aprašymas	indeksas (cinkuotas plienas)	angos skersmuo [mm]	sriegio dydis
Banjo adapteris R-G tipo su išor. metriniu sriegiu, sandinimas 60° kūgis 	EC-106908	8	M10x1
	EC-106910	10	M12x1,5
	EC-106912	12	M14x1,5
	EC-106913	14	1/4" BSP
	EC-106914	14	M14x1,5
	EC-106915	14	M16x1,5
	EC-106916	16	M18x1,5
	EC-106918	18	M22x1,5



aprašymas	indeksas (cinkuotas plienas)	angos skersmuo [mm]	išor. vamzdelio skersmuo [mm]	sriegio dydis [mm]
Banjo adapetris R-G-L tipo su išor. metriniu sriegiu, sandinimas 24° kūgis 	EC-106950	8	5	M10x1
	EC-106952	10	6	M12x1,5
	EC-106954	12	8	M14x1,5
	EC-106956	14	8	M14x1,5
	EC-106958	14	10	M16x1,5
	EC-106960	16	12	M18x1,5
	EC-106961	18	12	M18x1,5
	EC-106962	18	15	M22x1,5
	EC-106964	22	15	M22x1,5
	EC-106963	26	18	M26x1,5

aprašymas	indeksas (cinkuotas plienas)	sriegio dydis	ilgis be galvutės [mm]	rakto dydis [mm]
Varžtas HS tipo, skirtas banjo (panašus į DIN 7643) 	EC-107006	M6x1	17	11
	EC-107008	M8x1	17	12
	EC-107009	M8x1,25	17	12
	EC-107010	M10x1	19	14
	EC-107011	M10x1,5	19	14
	EC-107012	M12x1,5	24	17
	EC-107014	M14x1,5	26	19
	EC-107016	M16x1,5	28	22
	EC-107018	M18x1,5	32	24
	EC-107022	M22x1,5	39	27
	EC-107026	M26x1,5	45	32
	EC-107030	M30x1,5	51	36
	EC-107040	1/8"	19	14
	EC-107041	1/4"	26	19
	EC-107042	3/8"	28	22
	EC-107043	1/2"	39	27

aprašymas	indeksas (cinkuotas plienas)	sriegio dydis	ilgis be galvutės [mm]	rakto dydis
Dvigubas varžtas DHS tipo, skirtas banjo 	EC-107108	M8x1	27	12
	EC-107110	M10x1	30	14
	EC-107112	M12x1,5	38	17
	EC-107114	M14x1,5	42	19
	EC-107116	M16x1,5	46	22
	EC-107118	M18x1,5	54	24
	EC-107122	M22x1,5	66	27
	EC-107126	M26x1,5	77	32

ANTGALIAI IR JUNGTYŠ ŽARNOMS

EC tipo antgaliai

aprašymas	indeksas (cinkuotas plienas)	sutartinis nominalus skersmuo DN	apytikslis vid. žarnos skersmuo [mm]	išor. vamzdelio skersmuo [mm]
<p>Vamzdinis antgalis RST tipo</p> 	EC-108504	2	3,5	4
	EC-108505	3	4,5	5
	EC-108506	4	5,5	6
	EC-108508	6	7,5	8
	EC-108510	8	9,5	10
	EC-108512	10	11,5	12
	EC-108515	12	14,5	15
	EC-108518	16	17	18
<p>Vamzdinis 90° kampinis antgalis RBS tipo</p> 	EC-108304	2,5	3,5	5
	EC-108305	3	4,5	5
	EC-108306	4	5,5	5
	EC-108308	6	7,5	8
	EC-108310	8	9,5	10
	EC-108312	10	11,5	12
	EC-108315	12	14,5	15
	EC-108318	16	17	18
<p>Vamzdinis 45° kampinis antgalis RBS tipo</p> 	EC-108307	4	5,5	5
	EC-108309	6	7,5	8
	EC-108311	8	9,5	10
	EC-108313	10	11,5	12
	EC-108316	12	14,5	15

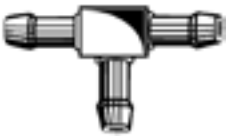
aprašymas	indeksas (cinkuotas plienas)	sutartinis nominalus skersmuo DN	apytikslis vid. žarnos skersmuo [mm]
<p>Trišakis TSM tipo</p> 	EC-127829	2	4,5
	EC-127830	4	5,5
	EC-127831	6	7,5
	EC-127832	8	9,5
	EC-127833	10	11,5

aprašymas	indeksas (cinkuotas plienas)	rakto dydis [mm]	1 sriegio dydis [mm]	2 sriegio dydis [mm]
<p>Adapteris DST tipo su išor. metrinu sriegiu, 60° kūgis</p> 	EC-122010	14	M10x1	M10x1
	EC-122012	14	M12x1,5	M12x1,5
	EC-122014	19	M14x1,5	M14x1,5
	EC-122016	19	M16x1,5	M16x1,5
	EC-122018	19	M18x1,5	M18x1,5
	EC-122022	27	M22x1,5	M22x1,5
	EC-122026	32	M26x1,5	M26x1,5
<p>Adapteris RDST tipo su išor. metrinu sriegiu, 60° kūgis</p> 	EC-122050	12	M8x1	M10x1
	EC-122052	17	M10x1	M12x1,5
	EC-122054	17	M12x1,5	M14x1,5
	EC-122056	22	M12x1,5	M16x1,5
	EC-122060	22	M14x1,5	M16x1,5
	EC-122065	24	M16x1,5	M18x1,5
	EC-122070	27	M18x1,5	M22x1,5

ANTGALIAI IR JUNGTYŠ ŽARNOMS

EM tipo antgaliai ir jungtys žarnoms

Plastmasiniai antgaliai ir jungtys pagaminti iš polipropileno, PVDF ir PTFE yra plačiai naudojami laboratorijose, medicinoje, farmacijos, chemijos bei maisto pramonėje. Skirti plastikiniams minkštomis žarnoms (žiūrėti skyrius: žarnos TYGON®, silikoninės žarnos). Gaminamos ir su BSP bei NPT sriegiais.

aprašymas	indeksas (polipropilenas)	indeksas (PVDF)	indeksas (PTFE)	sriegio dydis [coliais]	vid. žarnos skersmuo [mm]
Antgalis su vid. BSP sriegiu 	EM-PWB-02-04PP	EM-PWB-02-04PV	EM-PWB-02-04PT	1/8	4
	EM-PWB-04-06PP	EM-PWB-04-06PV	-	1/4	6
	EM-PWB-06-08PP	EM-PWB-06-08PV	-	3/8	8
	EM-PWB-06-10PP	EM-PWB-06-10PV	EM-PWB-06-10PT	3/8	10
	EM-PWB-08-12PP	EM-PWB-08-12PV	-	1/2	12
	EM-PWB-08-14PP	EM-PWB-08-14PV	-	1/2	14
	EM-PWB-08-16PP	-	EM-PWB-08-16PT	1/2	16

- pavyzdinis indeksas angaliui su NPT sriegiu: EM-PWN-02-04PP

aprašymas	indeksas (polipropilenas)	indeksas (PVDF)	indeksas (PTFE)	sriegio dydis [coliais]	vid. žarnos skersmuo [mm]
Antgalis su išor. BSP sriegiu 	EM-PZB-02-04PP	EM-PZB-02-04PV	EM-PZB-02-04PT	1/8	4
	EM-PZB-04-06PP	EM-PZB-04-06PV	EM-PZB-04-06PT	1/4	6
	EM-PZB-06-08PP	EM-PZB-06-08PV	EM-PZB-06-08PT	3/8	8
	EM-PZB-06-10PP	EM-PZB-06-10PV	EM-PZB-06-10PT	3/8	10
	EM-PZB-08-12PP	EM-PZB-08-12PV	EM-PZB-08-12PT	1/2	12
	EM-PZB-08-14PP	EM-PZB-08-14PV	EM-PZB-08-14PT	1/2	14
	EM-PZB-08-16PP	EM-PZB-08-16PV	EM-PZB-08-16PT	1/2	16

- pavyzdinis indeksas angaliui su NPT sriegiu: EM-PZN-02-04PP

aprašymas	indeksas (polipropilenas)	indeksas (PVDF)	indeksas (PTFE)	sriegio dydis [coliais]	vid. žarnos skersmuo [mm]
Antgalis 90° su vid. BSP sriegiu 	EM-KWB-02-04PP	-	-	1/8	4
	EM-KWB-04-06PP	EM-KWB-04-06PV	-	1/4	6
	EM-KWB-06-08PP	EM-KWB-06-08PV	-	3/8	8
	EM-KWB-06-10PP	-	-	3/8	10
	EM-KWB-08-12PP	EM-KWB-08-12PV	-	1/2	12

- pavyzdinis indeksas angaliui su NPT sriegiu: EM-KWN-02-04PP

aprašymas	indeksas (polipropilenas)	indeksas (PVDF)	indeksas (PTFE)	sriegio dydis [coliais]	vid. žarnos skersmuo [mm]
Antgalis 90° su išor. BSP sriegiu 	EM-KZB-02-04PP	EM-KZB-02-04PV	EM-KZB-02-04PT	1/8	4
	EM-KZB-04-06PP	EM-KZB-04-06PV	EM-KZB-04-06PT	1/4	6
	EM-KZB-06-08PP	EM-KZB-06-08PV	EM-KZB-06-08PT	3/8	8
	EM-KZB-06-10PP	EM-KZB-06-10PV	EM-KZB-06-10PT	3/8	10
	EM-KZB-08-12PP	EM-KZB-08-12PV	-	1/2	12

- pavyzdinis indeksas angaliui su NPT sriegiu: EM-KZN-02-04PP

ANTGALIAI IR JUNGTYŠ ŽARNOMS

EM tipo antgaliai ir jungtys žarnoms

aprašymas	indeksas (polipropilenas)	indeksas (PVDF)	indeksas (PTFE)	vidinis žarnos skersmuo [mm]
<p>Paprasta jungtis</p> 	EM-LP-04PP	EM-LP-04PV	EM-LP-04PT	4
	EM-LP-06PP	EM-LP-06PV	EM-LP-06PT	6
	EM-LP-08PP	EM-LP-08PV	EM-LP-08PT	8
	EM-LP-10PP	EM-LP-10PV	EM-LP-10PT	10
	EM-LP-12PP	EM-LP-12PV	EM-LP-12PT	12

aprašymas	indeksas (polipropilenas)	indeksas (PVDF)	indeksas (PTFE)	vidinis žarnos skersmuo [mm]
<p>Jungtis 90°</p> 	EM-LK-04PP	EM-LK-04PV	EM-LK-04PT	4
	EM-LK-06PP	EM-LK-06PV	EM-LK-06PT	6
	EM-LK-08PP	EM-LK-08PV	EM-LK-08PT	8
	EM-LK-10PP	EM-LK-10PV	EM-LK-10PT	10
	EM-LK-12PP	EM-LK-12PV	EM-LK-12PT	12

aprašymas	indeksas (polipropilenas)	indeksas (PVDF)	indeksas (PTFE)	vidinis žarnos skersmuo [mm]
<p>Jungtis - trišakis</p> 	EM-LT-04PP	EM-LT-04PV	EM-LT-04PT	4
	EM-LT-06PP	EM-LT-06PV	EM-LT-06PT	6
	EM-LT-08PP	EM-LT-08PV	EM-LT-08PT	8
	EM-LT-10PP	EM-LT-10PV	EM-LT-10PT	10
	EM-LT-12PP	EM-LT-12PV	EM-LT-12PT	12

ANTGALIAI IR JUNGTYŠ ŽARNOMS

NA tipo antgaliai ir jungtys žarnoms

Antgaliai ir jungtys yra skirti naudoti valdymo sistemose, sistemose, skirtose dujų ir skysčių transportavimui, vakuuminėse sistemose ir pan. Antgaliai yra pagaminti iš poliamido (PA6), o jungtys iš acetolio kopolimero (POM). Antgaliai gaminami ir su NPT sriegiu.

aprašymas	indeksas (poliamidas)	sriegio dydis	vidinis žarnos skersmuo [mm]	anga [mm]
Tiesus antgalis su išor. sriegiu	NA-7100052003	M5	3	2,5
	NA-7100001004	M8x1	4	2,5
	NA-7100002004	M8x1,25	4	2,5
	NA-7100003004	M10x1	4	2,5
	NA-7100004004	M12x1,5	4	2,5
	NA-7100005004	M14x1,5	4	2,5
	NA-7100010004	1/8" BSPT	4	2,5
	NA-7100011004	1/4" BSPT	4	2,5
	NA-7100004005	M12x1,5	5	3
	NA-7100005005	M14x1,5	5	3
	NA-7100011005	1/4" BSPT	5	3
	NA-7100003006	M10x1	6	4
	NA-7100004006	M12x1,5	6	4
	NA-7100005006	M14x1,5	6	4
	NA-7100010006	1/8" BSPT	6	4
	NA-7100011006	1/4" BSPT	6	4
	NA-7100012006	3/8" BSPT	6	4
	NA-7100003008	M10x1	8	5,6
	NA-7100004008	M12x1,5	8	5,6
	NA-7100005008	M14x1,5	8	5,6
	NA-7100007008	M18x1,5	8	5,6
	NA-7100049008	M22x1,5	8	5,6
	NA-7100009008	M26x1,5	8	5,6
	NA-7100010008	1/8" BSPT	8	5,6
	NA-7100011008	1/4" BSPT	8	5,6
	NA-7100012008	3/8" BSPT	8	5,6
	NA-7100013008	1/2" BSPT	8	5,6
	NA-7100004010	M12x1,5	10	7
	NA-7100005010	M14x1,5	10	7
	NA-7100006010	M16x1,5	10	7
	NA-7100011010	1/4" BSPT	10	7
	NA-7100012010	3/8" BSPT	10	7
	NA-7100006012	M16x1,5	12	8,6
	NA-7100007012	M18x1,5	12	8,6
	NA-7100049012	M22x1,5	12	8,6
	NA-7100009012	M26x1,5	12	8,6
	NA-7100012012	3/8" BSPT	12	8,6
	NA-7100013012	1/2" BSPT	12	8,6
	NA-7100007014	M18x1,5	14	10
	NA-7100008014	M20x1,5	14	10
	NA-7100019014	M22x1,5	14	10
	NA-7100012014	3/8" BSPT	14	10
	NA-7100013014	1/2" BSPT	14	10
NA-7100009016	M26x1,5	16	12	
NA-7100013016	1/2" BSPT	16	12	
NA-7100014016	3/4" BSPT	16	12	
NA-7100009019	M26x1,5	19	15	
NA-7100014019	3/4" BSPT	19	15	
NA-7100015025	1" BSPT	25	21	



ANTGALIAI IR JUNGTYŠ ŽARNOMS

NA tipo antgaliai ir jungtys žarnoms

aprašymas	indeksas (poliamidas)	sriegio dydis	vidinis žarnos skersmuo [mm]	anga [mm]
Antgalis "T" su išor. sriegiu 	NA-7200001004	M8x1	4	2,5
	NA-7200003004	M10x1	4	2,5
	NA-7200004004	M12x1,5	4	2,9
	NA-7200005004	M14x1,5	4	2,5
	NA-7200010004	1/8 BSPT	4	2,5
	NA-7200011004	1/4 BSPT	4	2,5
	NA-7200003006	M10x1	6	4
	NA-7200004006	M12x1,5	6	4
	NA-7200010006	1/8 BSPT	6	4
	NA-7200011006	1/4 BSPT	6	4
	NA-7200004008	M12x1,5	8	5,6
	NA-7200005008	M14x1,5	8	5,6
	NA-7200011008	1/4 BSPT	8	5,6
NA-7200012010	3/8 BSPT	10	7	

aprašymas	indeksas (poliamidas)	vidinis žarnos skersmuo [mm]	anga [mm]
Tiesi jungtis 	NA-7500000003	3	2,5
	NA-7500000004	4	2,7
	NA-7500000005	5	3
	NA-7500000006	6	4
	NA-7500000008	8	5,6
	NA-7500000010	10	7
	NA-7500000012	12	8,6
	NA-7500000013	13	8,6
	NA-7500000014	14	10
	NA-7500000016	16	12
	NA-7500000019	19	15
	NA-7500000025	25	21

aprašymas	indeksas (poliamidas)	vidinis žarnos skersmuo [mm]	anga [mm]
Kampinė 90° jungtis 	NA-7620000003	3	2,5
	NA-7620000004	4	2,5
	NA-7620000005	5	3
	NA-7620000006	6	4
	NA-7620000008	8	5,6
	NA-7620000010	10	7
	NA-7620000012	12	8,6
	NA-7620000013	13	8,6
	NA-7620000014	14	10
	NA-7620000015	15	11
	NA-7620000016	16	12
	NA-7620000019	19	15
	NA-7620000025	25	21

ANTGALIAI IR JUNGTYŠ ŽARNOMS

NA tipo antgaliai ir jungtys žarnoms

aprašymas	indeksas (poliamidas)	vidinis žarnos skersmuo [mm]	anga [mm]
<p>Jungtis „Y”</p> 	NA-7700000003	3	2,5
	NA-7700000004	4	2,5
	NA-7700000005	5	3
	NA-7700000006	6	4
	NA-7700000008	8	5,6
	NA-7700000010	10	7
	NA-7700000012	12	8,6
	NA-7700000013	13	9
	NA-7700000014	14	10
	NA-7700000016	16	12
	NA-7700000019	19	15

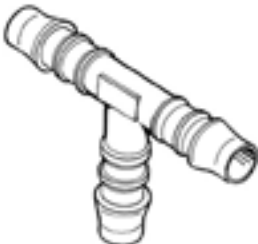
aprašymas	indeksas (poliamidas)	vidinis žarnos skersmuo [mm]	anga [mm]
<p>Jungtis „T”</p> 	NA-7600000003	3	2,5
	NA-7600000004	4	2,7
	NA-7600000005	5	3
	NA-7600000006	6	4
	NA-7600000007	7	5
	NA-7600000008	8	5,6
	NA-7600000010	10	7
	NA-7600000012	12	8,6
	NA-7600000013	13	8,6
	NA-7600000014	14	10
	NA-7600000015	15	11
	NA-7600000016	16	12
	NA-7600000019	19	15
	NA-7600000025	25	21

aprašymas	indeksas (poliamidas)	vidinis žarnos skersmuo [mm]	anga [mm]
<p>Jungtis „X”</p> 	NA-7720000004	4	2,9
	NA-7720000005	5	3
	NA-7720000006	6	4
	NA-7720000012	12	8,6

ANTGALIAI IR JUNGTYŠ ŽARNOMS

AK tipo antgaliai ir jungtys

paveikslas	indeksas	sriegio dydis [BSP]	flanšo skersmuo [mm]	žarnos skersmuo [coliais]	angos skersmuo [mm]	aprašymas
	AK-RVST13-C17-SP	1/2	17	1/2	10	Antgalis su išoriniu BSP sriegiu, su spyruokle, saugančia nuo sulaužymo, 200 mm. Medžiaga: nerūd. plienas. Darb. slėgis: iki 40 barų.
	AK-RVST13-C20-SP	1/2	20	1/2	10	
	AK-RVST16-C21-SP	1/2	21	5/8	13	
	AK-RVST19-C24-SP	1/2	24	3/4	14	

paveikslas	indeksas	sriegio dydis [BSP]	flanšo skersmuo [mm]	žarnos skersmuo [coliais]	angos skersmuo [mm]	aprašymas
	AK-SWIB13-C17	1/2	17	1/2	10	Sukamasis antgalis su išoriniu NPT sriegiu. Medžiaga: nerūd. plienas. Darb. slėgis: iki 40 barų. *- su spyruokle, saugančia nuo sulaužymo, 200 mm.
	AK-SWIB13-C20	1/2	20	1/2	10	
	AK-SWIB13-C20-SP*	1/2	20	1/2	10	
	AK-SWIB16-C21	1/2	21	5/8	13	
	AK-SWIB16-C21SP*	1/2	21	5/8	13	
	AK-SWIB19-C24	1/2	24	3/4	14	
	AK-SWIB19-C24SP*	1/2	24	3/4	14	

paveikslas	indeksas	vidinis sriegio dydis	išorinis sriegio dydis	angos skersmuo [mm]	medžiaga	aprašymas
	AK-SWM-09-1/2	1/2"	1/2"	9	žalvaris	Sukamoji jungtis su vidiniu ir išoriniu sriegiu. Darb. slėgis: iki 30 barų. Tarpikliai: - EPDM žalvariui - Vitonas nerūd. plienui
	AK-SWM-09-3/4	3/4"	1/2"	9		
	AK-SWM-12-3/4	3/4"	3/4"	12		
	AK-SWM-14-3/4	3/4"	1/2"	14		
	AK-SWM-18-1	1"	1"	18	nerūd. plienas	
	AK-SWR-09-1/2	1/2"	1/2"	9		
	AK-SWR-09-3/4	3/4"	1/2"	9		
	AK-SWR-12-3/4	3/4"	3/4"	12		
	AK-SWR-14-3/4	3/4"	1/2"	14	chrom. žalvaris	
	AK-SWR-18-1	1"	1"	18		
	AK-SWC-09-1/2	1/2"	1/2"	9		
	AK-SWC-09-3/4	3/4"	1/2"	9		
AK-SWC-14-3/4	3/4"	1/2"	14			

ANTGALIAI IR JUNGTYŠ ŽARNOMS

NiTO antgaliai ir jungtys žarnoms

Medžiaga: Žalvaris
Darbinis slėgis: 25 barai
Darbinė temp.: Iki +80°C



indeksas	sriegio dydis [coliais]	žarnos skersmuo [coliais]	aprašymas
NT-27110A4	1/2	1/2	Antgalis žarnai su išoriniu BSP sriegiu.
NT-27210A4	3/4	3/4	
NT-27240A4	3/4	1	
NT-27790A4	3/4	1/2	
NT-27410A4	1	1	
NT-27710A4	1.1/4	1.1/4	
NT-27810A4	1.1/2	1.1/2	
NT-27910A4	2	2	



indeksas	sriegio dydis	žarnos skersmuo [coliais]	aprašymas
NT-27150A4	1/2"	1/2	Antgalis žarnai su vidiniu BSP sriegiu.
NT-2715AA4	M22x1	3/4	
NT-2715BA4	1/2"	1/4	
NT-2721MA4	1/2"	5/8	
NT-2722MA4	3/4"	5/8	
NT-27250A4	3/4"	3/4	
NT-27350A4	3/4"	1/2	

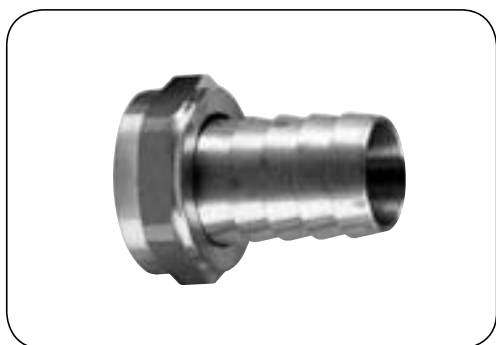

indeksas	sriegio dydis [coliais]	žarnos skersmuo [coliais]	aprašymas
NT-27450A4	1	1	Antgalis žarnai su vidiniu BSP sriegiu
NT-27550A4	1	1/2	
NT-27650A4	1	3/4	
NT-27750A4	1.1/4	1.1/4	
NT-27850A4	1.1/2	1.1/2	
NT-27950A4	2	2	

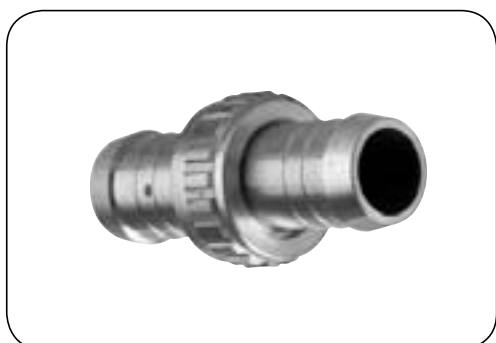

indeksas	žarnos skersmuo [coliais]	žarnos skersmuo [coliais]	aprašymas
NT-27160A4	1/2	1/2	Susukama jungtis žarnai.
NT-27260A4	3/4	3/4	
NT-27360A4	1/2	3/4	

ANTGALIAI IR JUNGTYŠ ŽARNOMS

NiTO antgaliai ir jungtys žarnoms

Medžiaga: Žalvaris
Darbinis slėgis: 25 barai
Darbinė temp.: Iki +80°C



indeksas	sriegio dydis [coliais]	žarnos skersmuo [mm]	aprašymas
NT-27L42A4	1/2	(nuo 15 iki 6,3)	Universalus antgalis žarnai su vidiniu BSP sriegiu.



indeksas	sriegio dydis [coliais]	matmenys [mm]	aprašymas
NT-1-290A8	1/2	18x12,4x2	Tarpiklis jungtims.
NT-1-300A8	3/4	23x16,7x2	
NT-1-320A8	1	29x23x2,5	
NT-1-900A8	1.1/4	38x29x2	
NT-1-910A8	1.1/2	44x34x2	
NT-1-920A8	2	55x45x2	



indeksas	žarnos skersmuo [coliais]	aprašymas
NT-15020A4	1/2	Jungtis žarnoms.
NT-15030A4	3/4	
NT-15040A4	1	



indeksas	sriegio dydis [coliais]	suveržimo diapazonas [mm]	aprašymas
NT-57078A5	3/4	14 iki 20	Gnybtas su išoriniu sriegiu 3/4" sklendės išpiltuvui be sriegio.
NT-57079A5	3/4	22 iki 30	

ANTGALIAI IR JUNGTYŠ ŽARNOMS

NiTO antgaliai ir jungtys žarnoms

Medžiaga: Žalvaris
Darbinis slėgis: 25 barai



indeksas	sriegio dydis [coliais]	žarnos skersmuo	aprašymas
NT-2760AA4	1/8	1/8" (3,5 mm)	Jungtis žarnai su išoriniu cilindrinu BSP sriegiu.
NT-2764AA4	1/8	1/4" (6,5 mm)	
NT-2766AA4	1/8	3/8" (10,2 mm)	
NT-2760BA4	1/4	1/4" (6,5 mm)	
NT-2768BA4	1/4	5/16" (8,5 mm)	
NT-2764BA4	1/4	3/8" (10,2 mm)	
NT-2766BA4	1/4	1/2" (13,5 mm)	
NT-2764CA4	3/8	1/4" (6,5 mm)	
NT-2760CA4	3/8	3/8" (10,2 mm)	
NT-2766CA4	3/8	1/2" (13,5 mm)	
NT-2764DA4	1/2	1/4" (6,5 mm)	
NT-2768DA4	1/2	5/16" (8,5 mm)	
NT-2766DA4	1/2	3/8" (10,2 mm)	
NT-2760DA4	1/2	1/2" (13,5 mm)	
NT-2764NA4	1/2	5/8" (16,5 mm)	
NT-2766NA4	1/2	3/4" (19,5 mm)	
NT-2766EA4	3/4	1/2" (13,5 mm)	
NT-2760EA4	3/4	3/4" (19,5 mm)	
NT-2760FA4	1	1" (26 mm)	
NT-2760GA4	1.1/4	1.1/4" (32 mm)	
NT-2760HA4	1.1/2	1.1/2" (39 mm)	
NT-2760IA4	2	2" (51 mm)	



indeksas	sriegio dydis [coliais]	žarnos skersmuo	aprašymas
NT-2660AA4	1/8	1/8" (3,5 mm)	Jungtis žarnai su išoriniu kūginiu BSPT sriegiu.
NT-2664AA4	1/8	1/4" (6,5 mm)	
NT-2666AA4	1/8	3/8" (10,2 mm)	
NT-2660BA4	1/4	1/4" (6,5 mm)	
NT-2668BA4	1/4	5/16" (8,5 mm)	
NT-2664BA4	1/4	3/8" (10,2 mm)	
NT-2666BA4	1/4	1/2" (13,5 mm)	
NT-2664CA4	3/8	1/4" (6,5 mm)	
NT-2660CA4	3/8	3/8" (10,2 mm)	
NT-2666CA4	3/8	1/2" (13,5 mm)	
NT-2664EA4	3/8	3/4" (19,5 mm)	
NT-2664DA4	1/2	1/4" (6,5 mm)	
NT-2668DA4	1/2	5/16" (8,5 mm)	
NT-2666DA4	1/2	3/8" (10,2 mm)	
NT-2660DA4	1/2	1/2" (13,5 mm)	
NT-2664NA4	1/2	5/8" (16,5 mm)	
NT-2666NA4	1/2	3/4" (19,5 mm)	
NT-2666EA4	3/4	1/2" (13,5 mm)	
NT-2660EA4	3/4	3/4" (19,5 mm)	
NT-2660FA4	1	1" (26 mm)	